

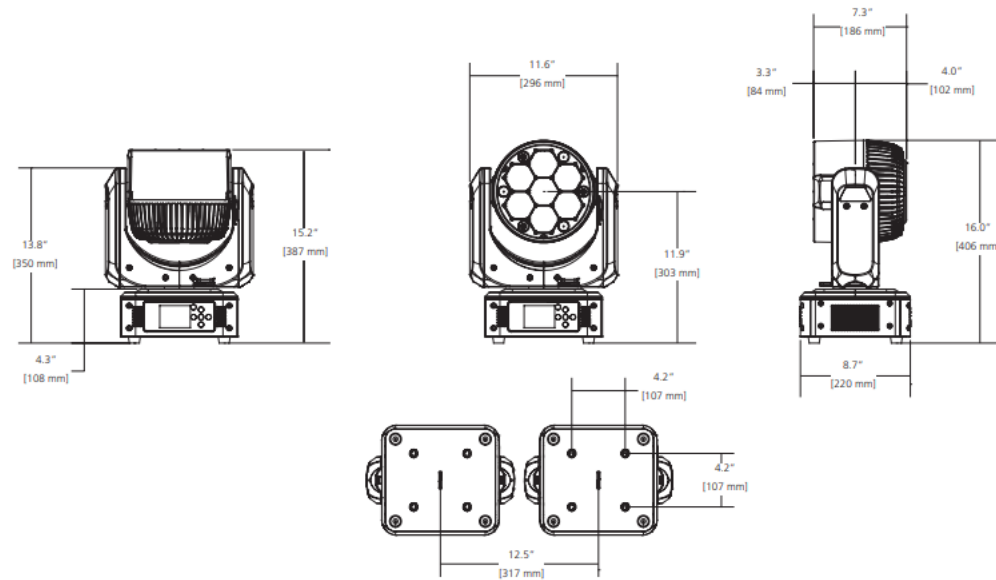

# HIGH END SYSTEMS



## SolaPix 7



# SolaPix 7

## Accessing the Electronics– Front Panel



Remove 2X Philips head screws

- Remove 2X Philips head screws from top plastic cover
- Remove 4X Philips head screws from front panel plastic cover
- Carefully remove both covers and set aside



Remove 2X countersink Philips head screws

# SolaPix 7

## Accessing the Electronics– Rear Panel

- Remove 2X Philips head screws from top plastic cover
- Remove 4X Philips head screws from front panel plastic cover
- Carefully remove both covers and set aside



Remove 2X Philips head screws

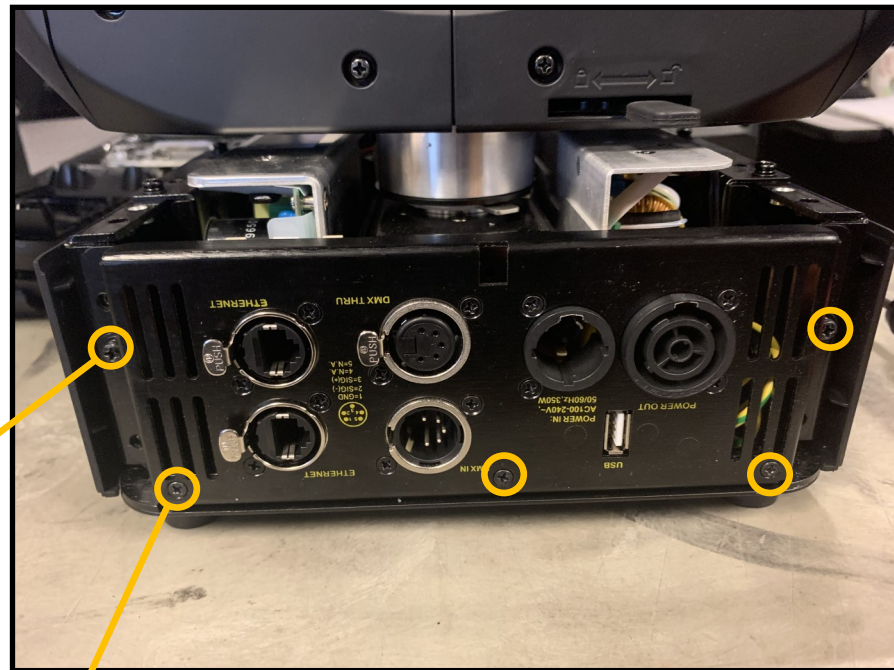

Remove 3X countersink Philips head screws



# SolaPix 7

## Front Panel Components

Input Power Supply 385VDV

Display Battery

Output Power Supply  
28VDC and 48VDC

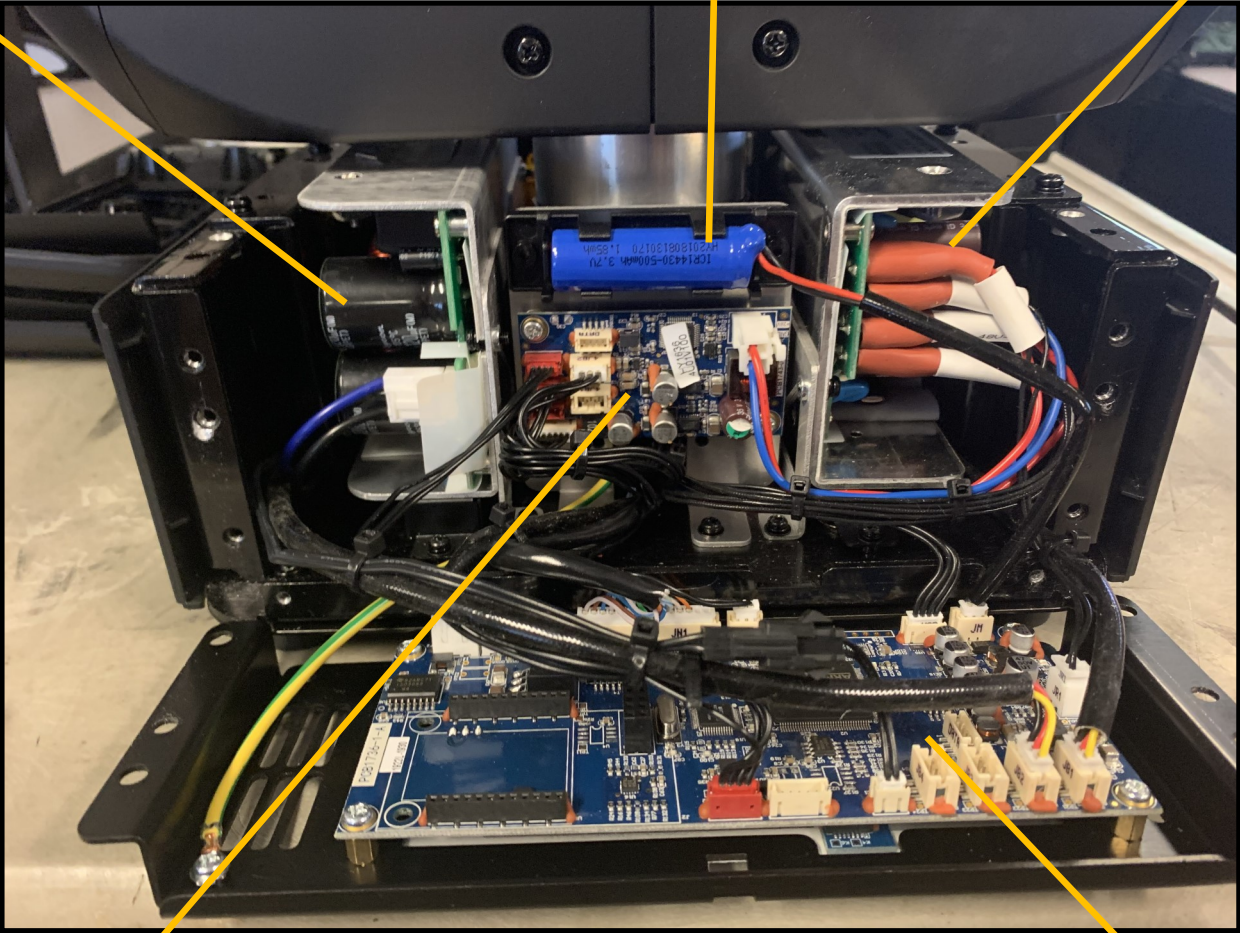

PCB Fan 4U

PCB Display 1U



# SolaPix 7

## Rear Panel Components

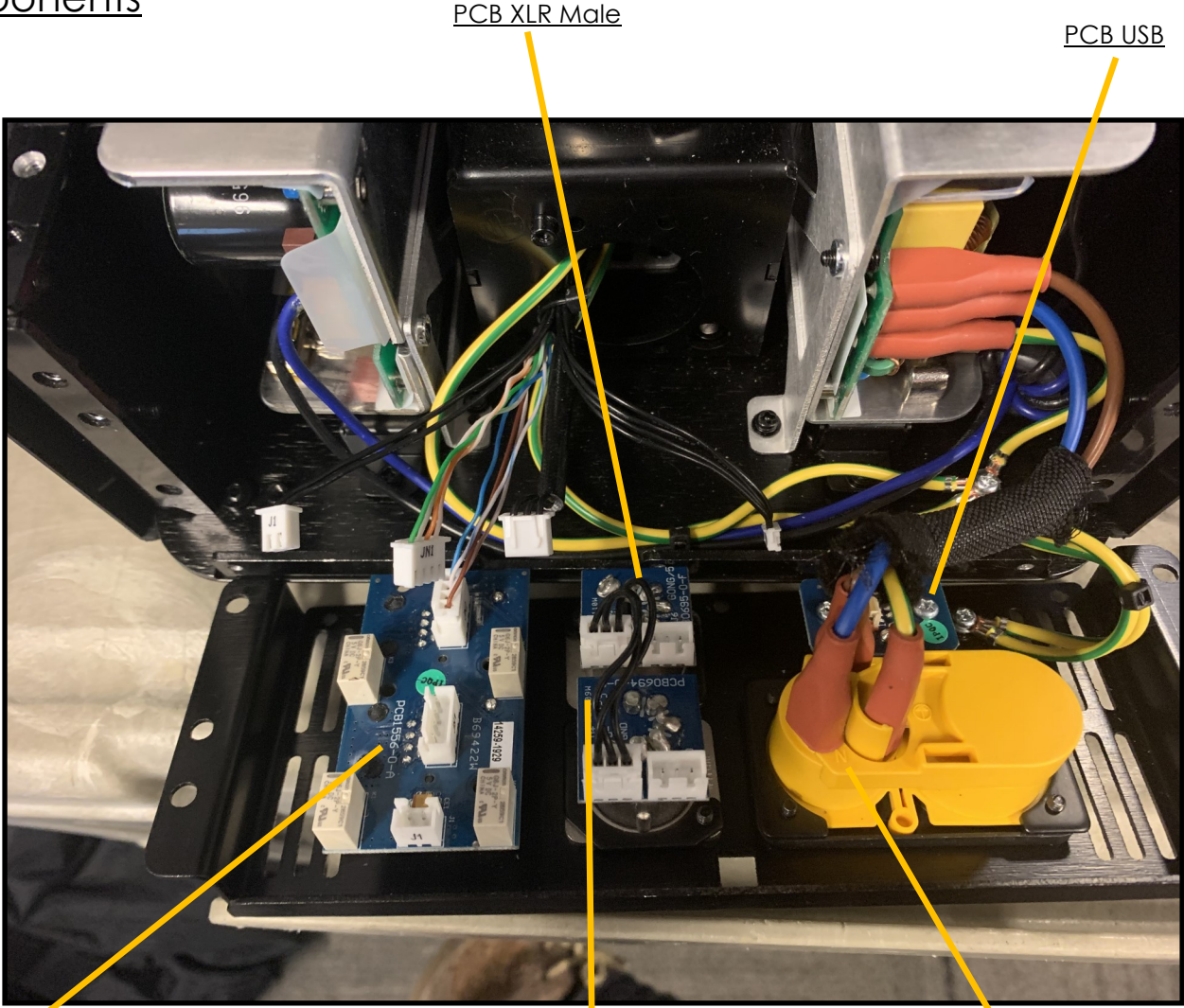

PCB Ethernet

PCB XLR Female

Power in/Power out  
AC 100V-240V

# SolaPix 7

## Removing the Output Power Supply



To make it easier to access/remove the 48V power supply, you may want to disconnect the JN1, J1 and USB connectors from the rear panel assembly in order to lay the panel more flat

*Each connector and connection point are labeled*

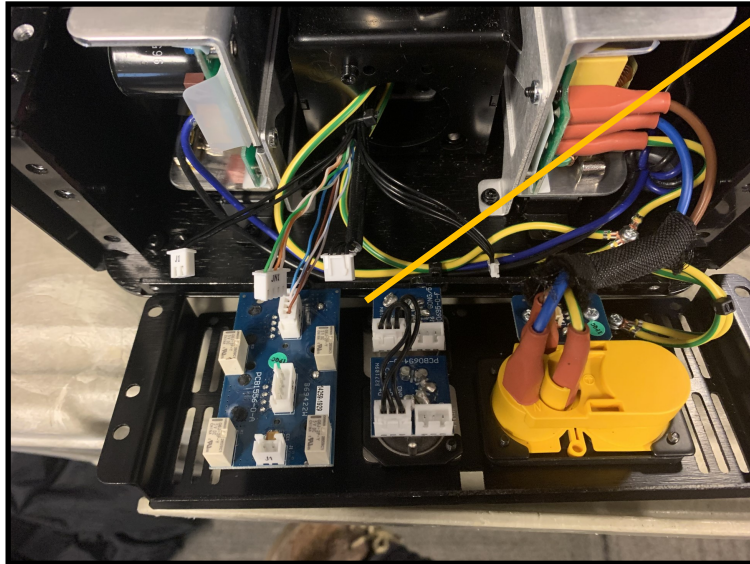

# SolaPix 7

## Removing the Output Power Supply

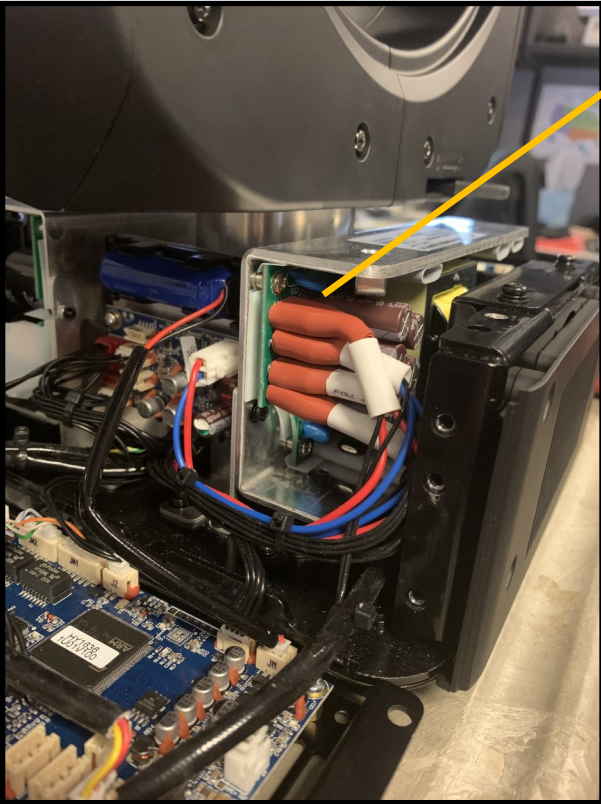

Remove all four wired connections to the power supply

*Each connection is labeled with a white silk-screened tag*

**In order from top to bottom:**

+28V

-28V

-48V

+48V

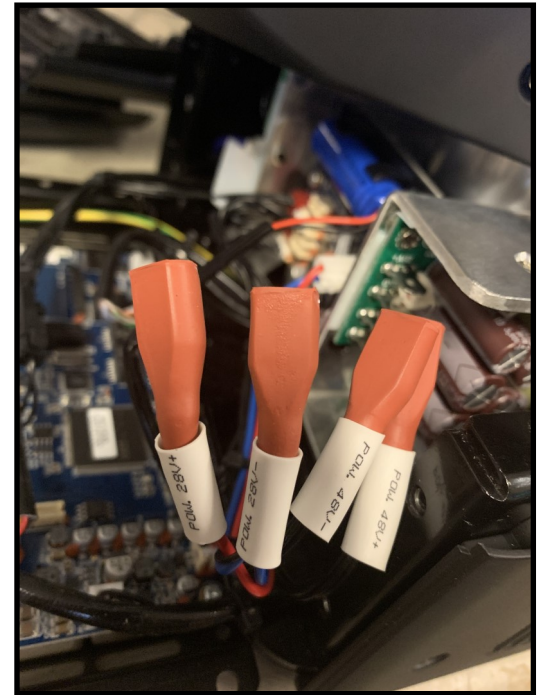



# SolaPix 7

## Removing the Output Power Supply

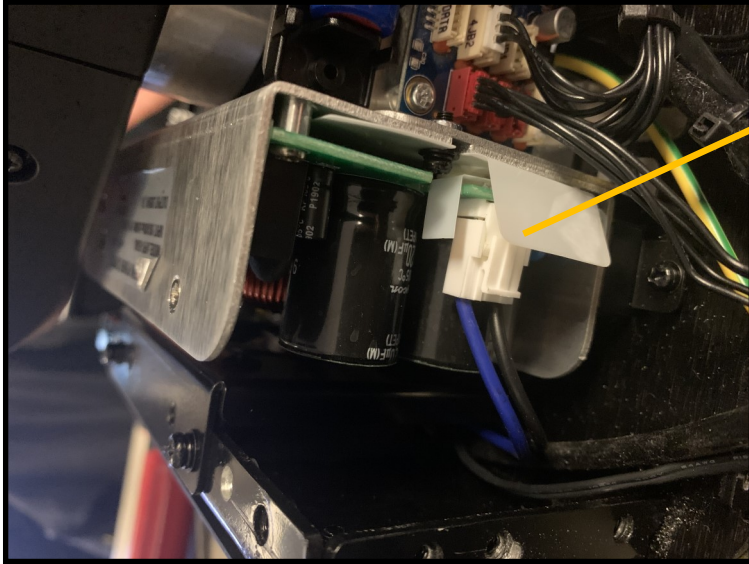

On the 385V Power Supply, disconnect the blue/black wired connection and feed it out towards the rear panel

Cut the zip tie near the rear panel to free the connector from the bunch

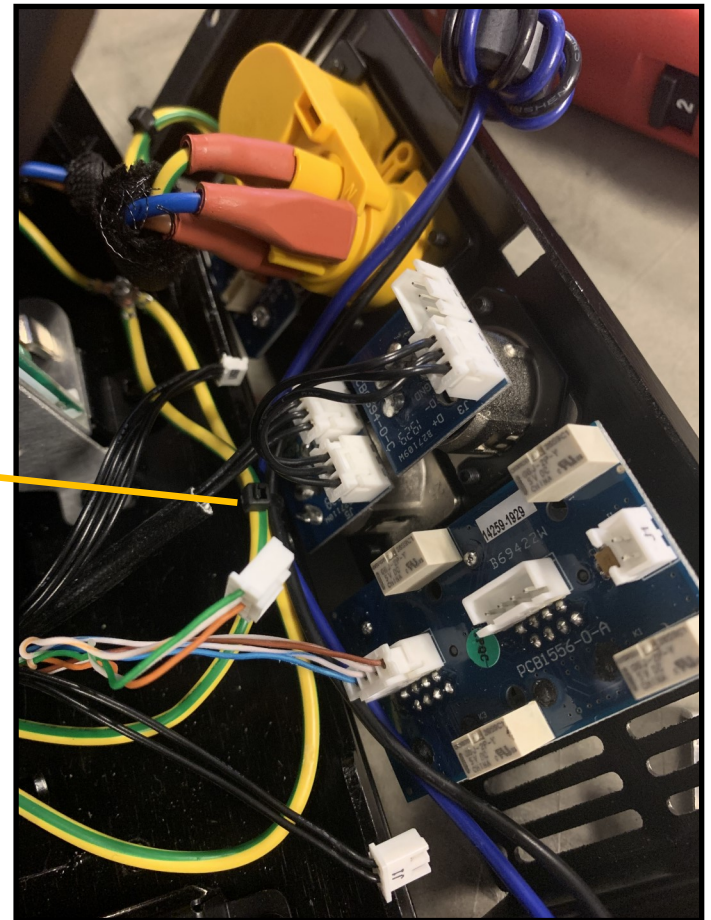

# SolaPix 7

## Removing the Output Power Supply

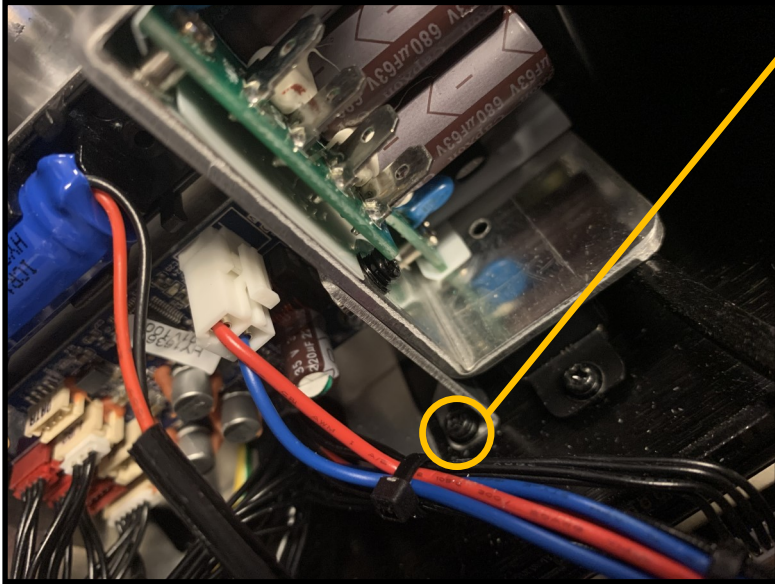

Now that the wired connections are all removed, remove 2X mounting screws on the silver power supply mounting plate (one on each side)



Carefully slide the power supply out towards the rear panel and remove mounting plate to install on new PSU

Apply a thin, even layer of heat sink compound to the new power supply before installing the mounting plate



# SolaPix 7

## Removing the Input Power Supply

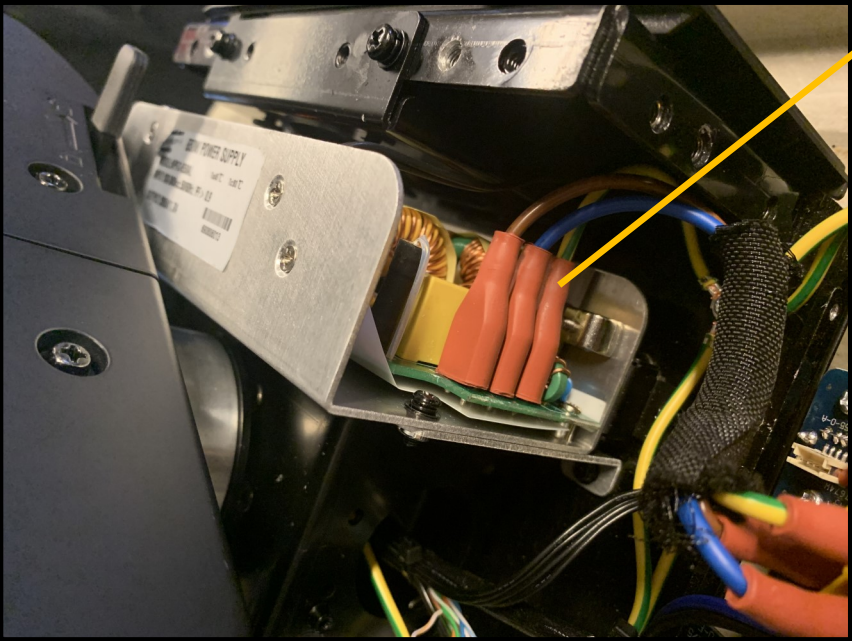

Disconnect the Live, Neutral, and Ground wire from the 385V Power Supply

If you haven't already removed the black/blue wired connection from the PSU, unseat that now





# SolaPix 7

## Removing the Input Power Supply

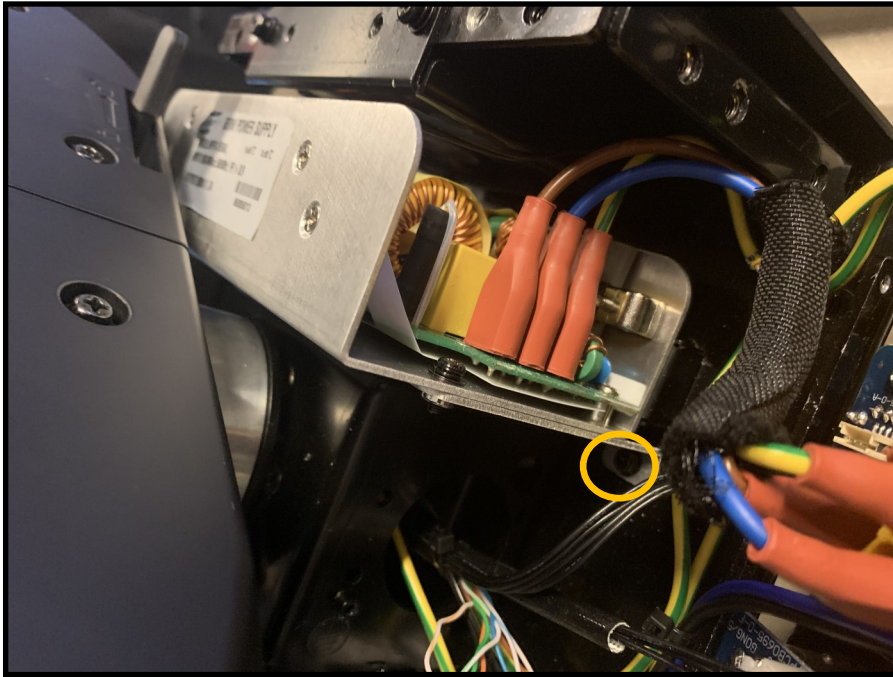

Now that the wired connections are all removed, remove 2X mounting screws on the silver power supply mounting plate (one on each side)

Carefully slide the power supply out towards the rear panel and remove mounting plate to install on new PSU

Apply a thin, even layer of heat sink compound to the new power supply before installing the mounting plate

# SolaPix 7

## Accessing the Yoke Components



Remove 2X Philips head arm cover screws (on each side)

Carefully remove plastic arm cover

Tilt Homing Sensor

Tilt Encoder Sensor

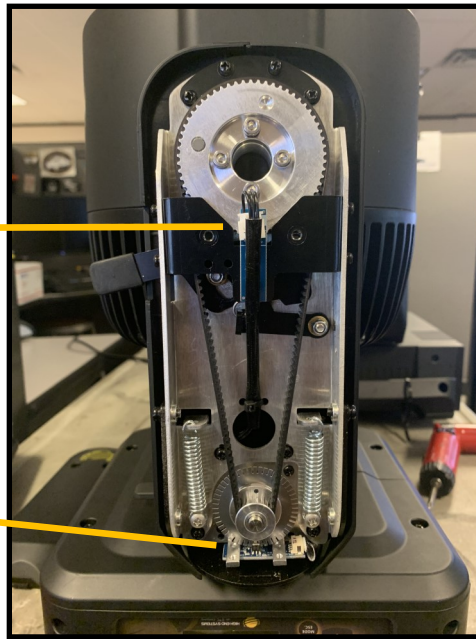

Pan Encoder Sensor

PCB Pan/Tilt 2U



# SolaPix 7

## Accessing the Yoke Components

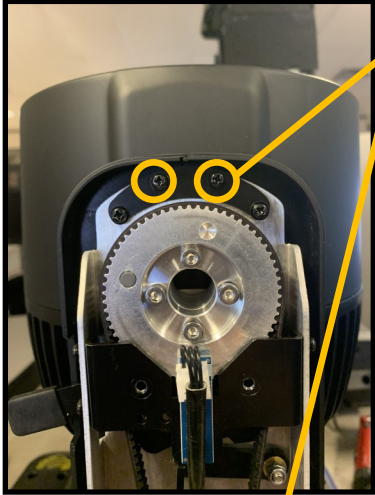

Remove 2X Philips screws on each arm

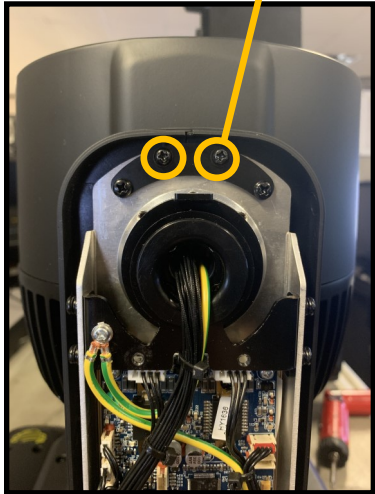

Remove 2X Philips head screws (on each of the 4 yoke covers)

Carefully remove yoke covers



# SolaPix 7

## Accessing the Yoke Components

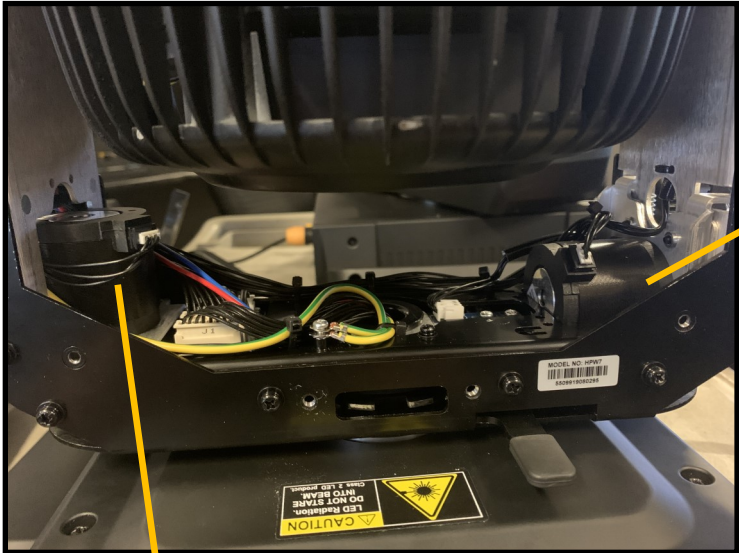

Motor Pan/Tilt

Motor Pan/Tilt

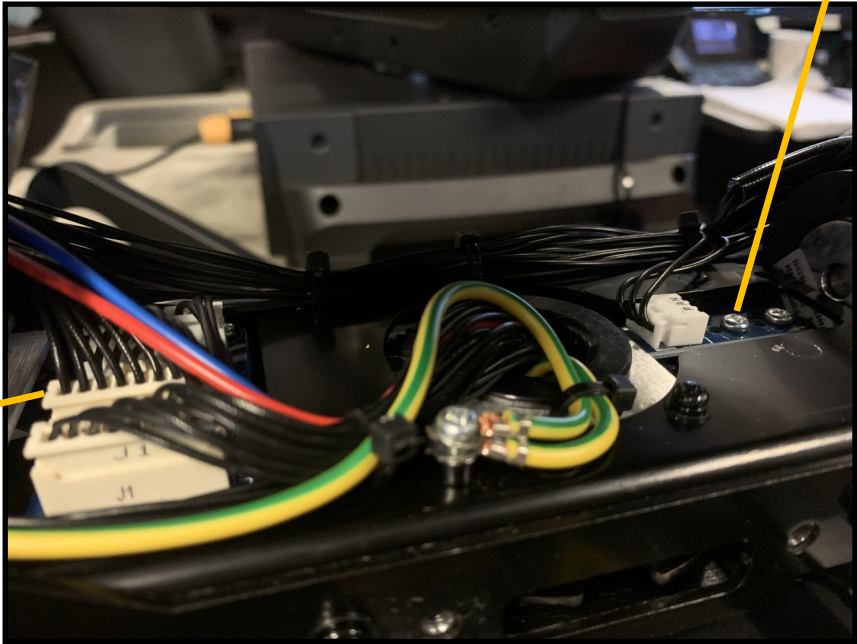

Pan Homing Sensor

PCB Junction Yoke

# SolaPix 7

## Accessing the Head Components



To remove the front lens cover, remove 3X countersink Philips screws from the back side of the fixture head.

*The images are all referencing working with the fixture with the pan and tilt lock facing you*

Now with all three screws removed the plastic front lens cover is loose and can be set aside.

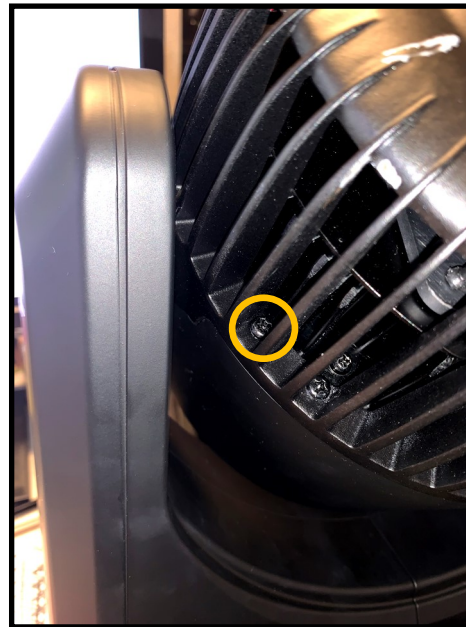

# SolaPix 7

## Accessing the Head Components



To remove the lens assembly:

Carefully use your hands to lift the lens assembly upwards as if it were zooming.

This will allow you access to the motor shaft.



Carefully hold the shaft in place so it does not spin but be sure to grab it as close to the top of the shaft as possible.

Using a 3.5mm nut driver, carefully loosen the nuts while still holding the motor shaft with pliers.

Set the nut and washer to the side.

Repeat on all three motors.



With the nuts and washers removed, you can now carefully lift up on the lens assembly and remove it.

When replacing the lens assembly be sure the zoom sensor magnet is lined up with the zoom sensor on the fixture.



# SolaPix 7

## Accessing the Head Components

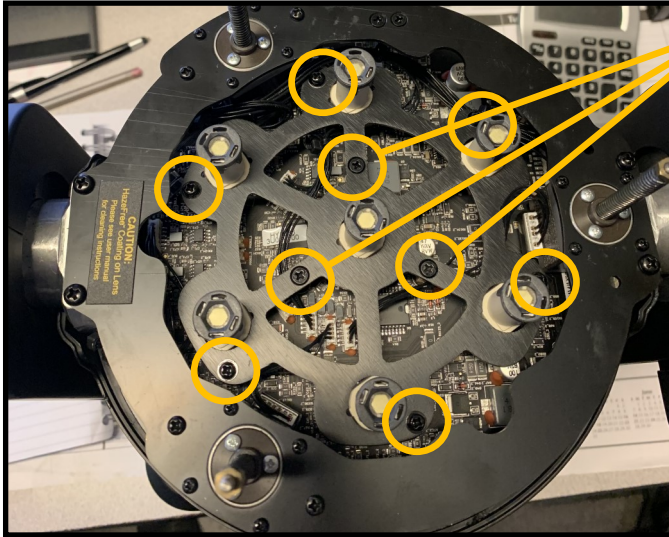

To remove light pipe fixing plate, remove 3X countersink Philips screws in the center and 6X Philips screws around the perimeter

**Be cautious when removing the fixing plate because the light pipes will be loose.**  
*If a light pipe falls/is moved, use the below images as a reference for putting them back. If they are not assembled correctly, the beam of the fixture will be changed.*

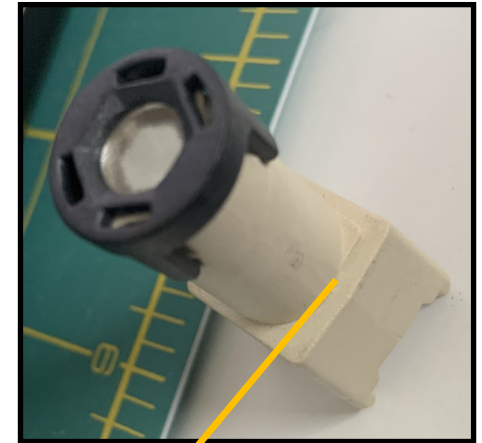

The Lightpipes all have a small indicator arrow on one of the four corners of the base.

The arrows must all be facing the same direction in relation to the CAUTION sticker shown in the image to the left.





# SolaPix 7

## Removing the LED Driver PCB



Using a 5mm nut driver carefully remove each brass standoff from the LED Driver PCB

*Use caution when removing/replacing standoffs as brass can easily scar or break*

The LED PCB can now be removed by placing a flat head screwdriver underneath and gently pulling upwards

Apply new heat sink compound to new LED PCB





# SolaPix 7

## PCB Function Guide

PCB Software ID	Controls
1U	Display
2U	Pan, Tilt
3U01	Dimmer, Zoom
3U02	Dimmer
3U03	Dimmer
4U01	Dimmer